

# **G** GRIPPLE®



High speed hanger  
solutions for the  
HVAC & Mechanical Industry

HVAC and Mechanical



No Tools Required  
**SELF-LOCKING**  
6 times faster



# Gripple History



*Since its launch in 1997, the Gripple hanger system has become universally recognized as the world's fastest and most cost effective way of installing electrical, mechanical and other suspended services. Through value engineering and advanced manufacturing practices, the Gripple team has brought to market a range of products which continues to grow and provide customers with outstanding features and benefits. And it's all down to the company's spirit of innovation.*

## ***Innovation*** the key to success at Gripple

The original Gripple was conceived back in the 1980s for use in joining and tensioning field fencing and trellising. Since then, more than 200 million units have been installed in over 70 countries worldwide. By the mid 1990s the Gripple team began work in joining wire a different way – vertically rather than horizontally. After numerous product revisions and countless hours of testing, the range of Gripple hangers was introduced to worldwide acclaim. The Gripple hanger system is unique because it incorporates both the hanger – the cable – and the means by which it is terminated and adjusted – the Gripple. Multiple cable end fixings have been, and continue to be developed to provide secure attachment solutions in every type of building situation. Gripple products have been developed in the field – in response to market needs and not the result of inventors locked away in laboratories. We will continue to work with end users, listen and learn, and provide quality solutions for the market.

Gripple hangers are now used across the United States and Canada in countless schools, hospitals, churches, retail stores, factories, warehouses and other commercial and industrial buildings. In fact, they can be found hanging services in the buildings of most of the Fortune 500 companies. Gripple hangers are UL and CSA listed and SMACNA verified. Gripple will continue to control manufacturing from its award winning ISO 9002 plant located in Sheffield, England. From its North American hub just outside Chicago, the team of dedicated employees look forward to being of service in all 50 states and every Canadian province.

Thank you for your interest in Gripple products. We hope you are able to identify a hanger system to meet your needs, but if not – call us, we'll make it for you !!



# About the Gripple

## Features & Benefits

- Gripple hangers are the **versatile** way to suspend static loads.
- Their **time saving** qualities have been shown to reduce installation by up to 6 times compared to threaded rod, chain, hanger strap, or other loose cable systems.
- Gripple hangers incorporate a length of pre-cut cable with a pre-fabricated end fixing for **maximum speed, efficiency and safety**.
- Their **lightness** is a major safety improvement, both in terms of carrying and storing the product easily on site and in reducing accident risk in aerial situations caused by falling materials.
- Gripple hangers are far less invasive than threaded rod and in fact enhance the **aesthetics** of installations.
- They allow the installer to position the hangers **vertically or at an angle** to the suspended object.
- Gripple hangers are available in **numerous configurations** for attachment to virtually any type of building structure.
- Gripple hangers are manufactured to **ISO 9002 standards** and carry certificates from the following agencies: **UL, SMACNA and ETL Intertek**.

**END-CAP:**  
UV stabilized homopolymer polypropylene

**STAINLESS SPRING:**  
Type 302 S26 stainless steel, hardened and tempered

**LOCKING WEDGES:**  
Oil impregnated, sintered, hardened and tempered steel

**ZINC-HOUSING:**  
One piece, die cast zinc, type ZA2

**CABLE:**  
Grade AISI 316 zinc galvanized BS 302

Size	Diameter	Construction
#1	3/64	7 x 7
#2	5/64	7 x 7
#3	1/8	7 x 7
#4	3/16	7 x 19
#5	1/4	7 x 19

Cable cross sections:

7 x 7

7 x 19



# Multiple End Fixings

*Loop*

*Stud Up*

*Stud Down*

*Toggle Up*

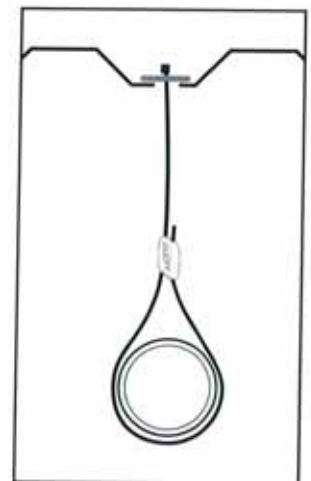
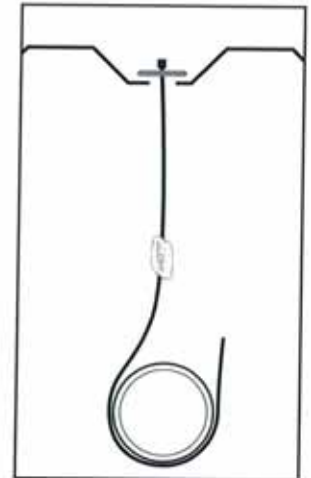
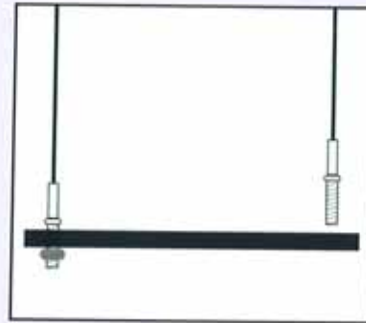
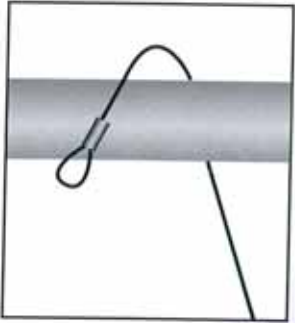
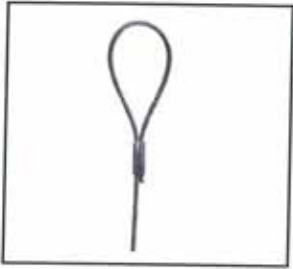

## Toggle Down

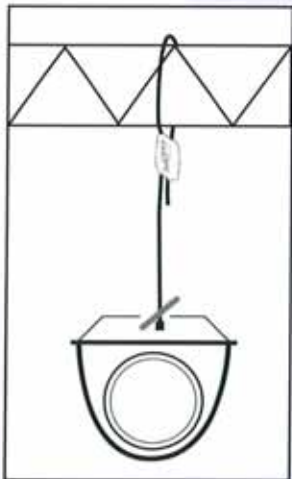
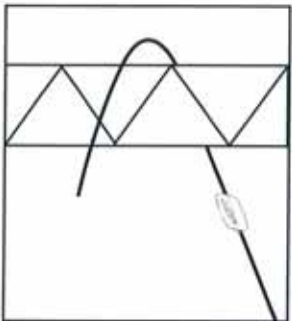
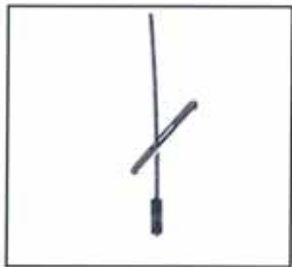

## Hook



## 90° Eyelet

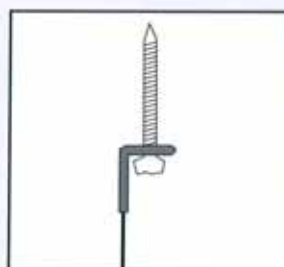

# 5 Sizes

Gripple hangers are available in five load rated sizes. Each size is designed to carry a specific weight range and has a designated working load limit (WLL). The WLL is common to each of the different end fixings. The WLL gives a minimum 5:1 safety factor in a vertical plane and applies to all lengths. Standard lengths range from 5 ft to 30 ft. Other lengths can be made to order.

## WORKING LOAD LIMITS

No. 1	0 - 22 lbs
No. 2	23 - 100 lbs
No. 3	101 - 200 lbs
No. 4	201 - 495 lbs
No. 5	496 - 715 lbs

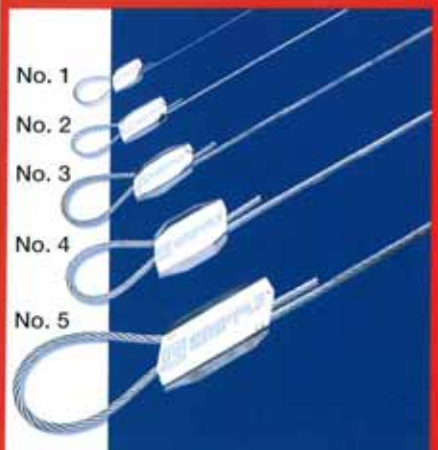

# Applications

## Spiral Duct

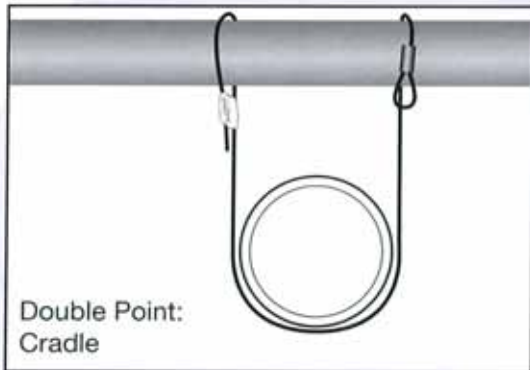
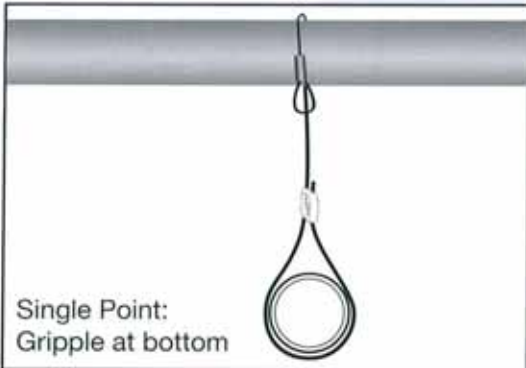
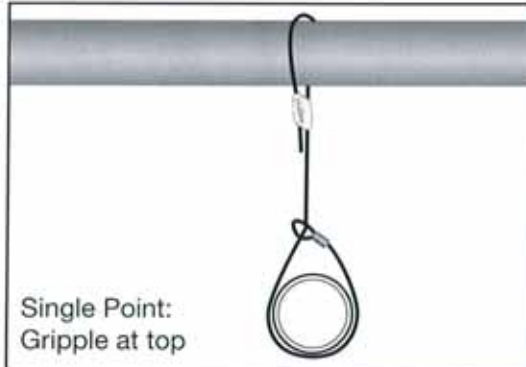

## Rectangular Duct

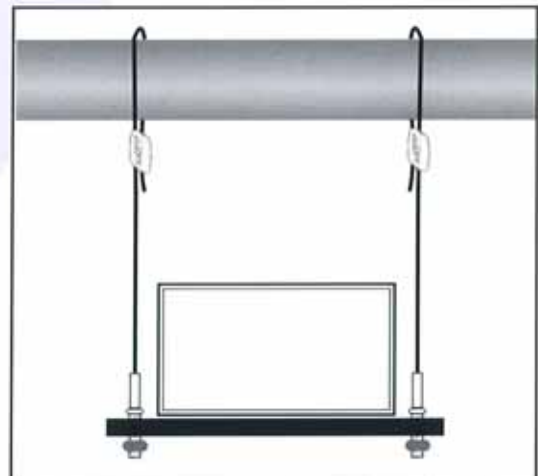
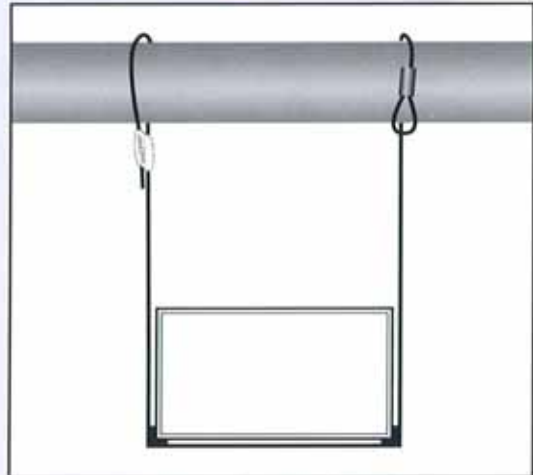

## Oval Duct

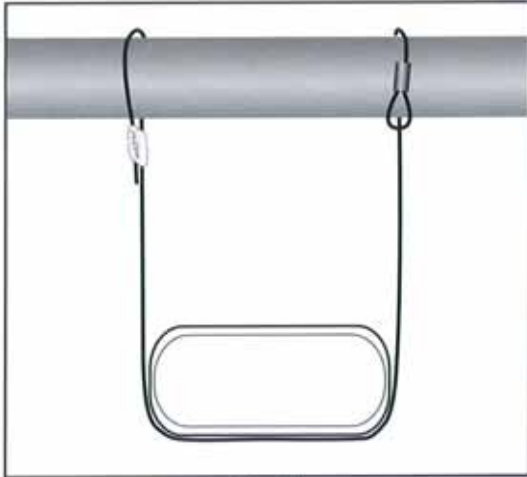

Cradle

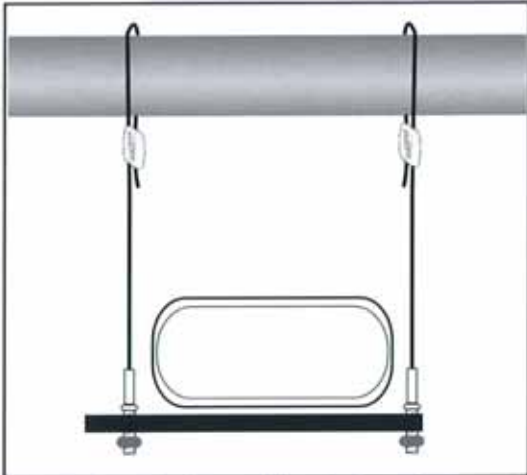

Two Gripple Assemblies & Strut Support



## Air Handling Units

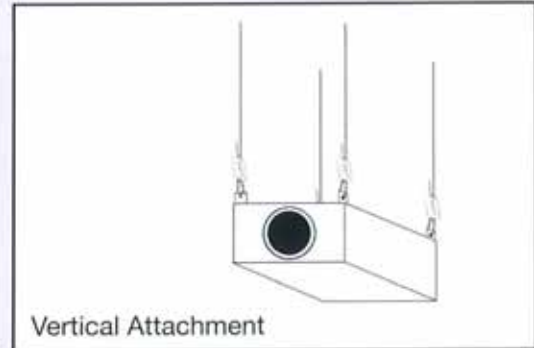

Vertical Attachment

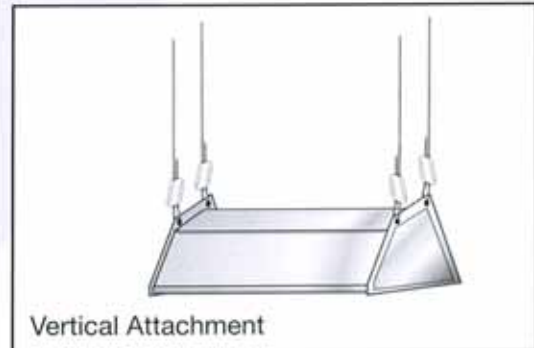

Vertical Attachment

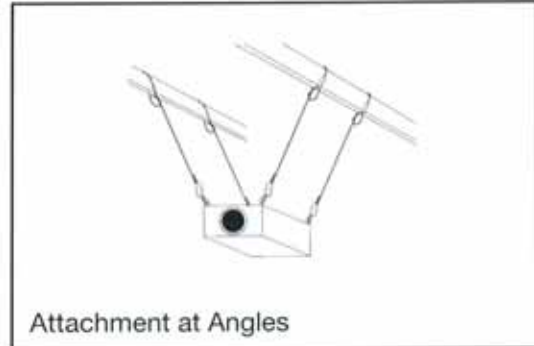

Attachment at Angles



# Applications

## Pipe Racks

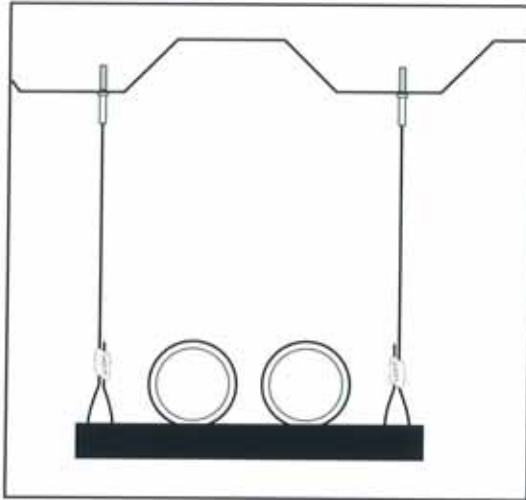

*Pipe on Strut*



*Small Diameter Copper Pipe  
(Insulated Cable)*



*Pipe Rack - Underground Mine*

## Seismic Bracing



*Photographs courtesy of Kinetics Noise Control*



# Size Charts/Technical

## Hanger Calculator

Please Note: Calculations do NOT take into account weight of connectors.

### Single Wall Spiral Duct: based on 10' hanger spacing

Pipe Diameter	Pipe Circumference	GRIPPLE SIZE		
		26 GAUGE	24 GAUGE	22 GAUGE
12"	3' 2"	2	2	2
16"	4' 2"	2	2	2
20"	5' 3"	2	2	2
24"	6' 3"	2	2	2
28"	7' 4"	2	2	3
32"	8' 5"	2	3	3
36"	9' 5"	2	3	3
40"	10' 6"	3	3	3
44"	11' 6"	3	3	3
48"	12' 7"	3	3	3
52"	13' 7"	3	3	4
56"	14' 8"	3	3	4
60"	15' 8"	3	4	4

### Double Wall Spiral Duct: based on 10' hanger spacing

Inside Diameter (in.)	Outside Gauge	Inside Gauge	Wt/Ft (lbs)	Gripplle Size
12"	26	26	8.0	2
16"	24	24	11.0	3
20"	24	24	13.4	3
24"	24	24	18.0	3
28"	22	24	22.3	4
32"	22	24	25.2	4
36"	20	22	31.2	4
40"	20	22	36.7	4
44"	20	22	40.2	4
48"	20	22	43.8	4
52"	18	20	56.2	5
56"	18	20	60.8	5

### Square/Rectangular Duct : based on 5' hanger spacing

Duct Size Total	SQ. FT.	GRIPPLE SIZE		
		26 GAUGE	24 GAUGE	22 GAUGE
20"	3.4	2	2	2
28"	4.8	2	2	2
36"	6.2	2	2	2
40"	6.9	2	2	2
48"	8.2	2	2	2
52"	8.9	2	2	2
60"	10.3	2	2	2
64"	11.0	2	2	2
72"	12.4	2	2	2
80"	13.7	2	2	2
84"	14.4	2	2	3
92"	15.8	2	2	3
96"	16.5	2	2	3
100"	17.2	2	3	3
116"	19.9	2	3	3
120"	20.6	2	3	3

## HOW TO USE THE CALCULATION CHARTS

- Select Gripplle size based on gauge of steel and duct dimensions (e.g., 44" Duct, 24 gauge = No. 2)

### Spiral

- Choose required diameter
- Choose required steel gauge
- Chart shows correct Gripplle size

### Rectangular

- Add vertical & horizontal planes to determine total duct size (e.g., 16" x 20" = 36")
- Choose required steel gauge
- Chart shows correct Gripplle size

## Hanging at Angles

Hanger Size	Maximum Load (lbs) at an Angle from Vertical				
	0° Vertical	15°	30°	45°	60°
#1	22	21	18	15	11
#2	100	96	86	70	50
#3	200	192	172	140	100
#4	495	475	425	346	247
#5	715	686	614	500	357
Load %	100	96	86	70	50

The load rating for a Gripplle hanger is based on the suspension being hung vertically. If the cable is suspended at an angle, an additional sideways load is applied, which reduces the load capacity of the suspension. The net effect is shown in the table above.

## Working Load Limits







- No. 1** 0-22 lbs
- No. 2** 23-100 lbs
- No. 3** 101-200 lbs
- No. 4** 201-495 lbs
- No. 5** 496-715 lbs



## Approvals & Testing

Gripplle products have been independantly tested & certified by the following agencies:













- \*SMACNA Testing & Research, Chantilly VA
- \*UL Underwriters Laboratories Inc, Northbrook IL
- \*CSA International, Cleveland OH
- \*RADCO Inc., Long Beach CA
- \*New York Testing Laboratories
- \*Architectural Testing, York PA
- \*Lloyds Register, England
- \*ETL - Intertek, Vancouver BC

# Hanger Kits

SIZE	CABLE LENGTH	TYPE OF END FIXING					
		 LOOP	 HOOK	 TOGGLE	 1/4" STUD	 3/8" STUD	 90° STUD EYELET
<b>NO. 1</b> 0 - 22 lbs	5FT	HF01-5FT					
	10FT	HF01-10FT					
	15FT	HF01-15FT					
	30FT	HF01-30FT					
<b>NO. 2</b> 23 - 100 lbs	5FT	HF02-5FT	HF-HK-NO2-5FT	HF-TG-NO2-5FT	HF-SG-NO2-5FT		HF-SEYEG90A-NO2-5FT
	10FT	HF02-10FT	HF-HK-NO2-10FT	HF-TG-NO2-10FT	HF-SG-NO2-10FT		HF-SEYEG90A-NO2-10FT
	15FT	HF02-15FT	HF-HK-NO2-15FT	HF-TG-NO2-15FT	HF-SG-NO2-15FT		HF-SEYEG90A-NO2-15FT
	30FT	HF02-30FT	HF-HK-NO2-30FT	HF-TG-NO2-30FT	HF-SG-NO2-30FT		HF-SEYEG90A-NO2-30FT
<b>NO. 2</b> STAINLESS STEEL 23 - 100 lbs	5FT	HF-IS-NO2-5FT	HF-HK-NO3-5FT		HF-ISSS-NO2-5FT-UNC		
	10FT	HF-IS-NO2-10FT	HF-HK-NO3-10FT		HF-ISSS-NO2-10FT-UNC		
	15FT	HF-IS-NO2-15FT	HF-HK-NO3-15FT		HF-ISSS-NO2-15FT-UNC		
	30FT	HF-IS-NO2-30FT	HF-HK-NO3-30FT		HF-ISSS-NO2-30FT-UNC		
<b>NO. 3</b> 101 - 200 lbs	5FT	HF03-5FT		HF-TG-NO3-5FT	HF-SG-NO3-5FT	HF-SG3/8-NO3-5FT	HF-SEYEG90A-NO3-5FT
	10FT	HF03-10FT		HF-TG-NO3-10FT	HF-SG-NO3-10FT	HF-SG3/8-NO3-10FT	HF-SEYEG90A-NO3-10FT
	15FT	HF03-15FT		HF-TG-NO3-15FT	HF-SG-NO3-15FT	HF-SG3/8-NO3-15FT	HF-SEYEG90A-NO3-15FT
	30FT	HF03-30FT		HF-TG-NO3-30FT	HF-SG-NO3-30FT	HF-SG3/8-NO3-30FT	HF-SEYEG90A-NO3-30FT
<b>NO. 3</b> STAINLESS STEEL 101 - 200 lbs	5FT	HF-IS-NO3-5FT			HF-SS-INOX-5FT-SS		
	10FT	HF-IS-NO3-10FT			HF-SS-INOX-10FT-SS		
	15FT	HF-IS-NO3-15FT			HF-SS-INOX-15FT-SS		
	30FT	HF-IS-NO3-30FT			HF-SS-INOX-30FT-SS		
<b>NO. 4</b> 201 - 495 lbs	5FT	HF04-5FT				HF-SG-3/8-NO4-5FT	
	10FT	HF04-10FT				HF-SG-3/8-NO4-10FT	
	15FT	HF04-15FT				HF-SG-3/8-NO4-15FT	
	30FT	HF04-30FT				HF-SG-3/8-NO4-30FT	
<b>NO. 5</b> 496 - 715 lbs	5FT	HF05-5FT					
	10FT	HF05-10FT					
	15FT	HF05-15FT					
	30FT	HF05-30FT					

Product	Part No.	Description	Case Qty.
 Cable Cutter	CUTTER-GRIPPLE	A purpose made tool for cutting cable. Suitable for use on the Gripple hanger sizes No. 1-4.	1
 Corner Saddle	HF-CORNER-SADDLE	A right-angled reinforcement molding for positioning and supporting Gripple hanger sizes No. 1-3 on rectangular duct.	100
 Wood Eyebolt	HF-EYEBOLT-WOOD-1/4-US	1/4" wood eyebolt with 1/2" eye opening for anchoring into wood beams, joists and trusses. For use with No. 1, 2 (and 3 up to 120lbs).	10

# Accessories

Product	Part No.	Description	Case Qty
Drop-in Anchor 	1/4" HF-DROPIN-ANCHOR-UNC	Punch activated drop-in anchors for fixing into concrete. Accepts Gripple stud-end fixing, pigtail anchor bolts and M6 adaptor (included in all stud kits as standard).	10
	6MM HF-DROPIN-ANCHOR		10
Setting Punch for Drop-in Anchor 	HF-SET-PUNCH	Setting Punch for use with 1/4" and 6mm drop-in anchor shown above.	1
6mm Thread Adaptor 	HF-ADAPTOR-UNIT	Ideal for fixing to luminaires, drop-in anchors, cable tray, hanging brackets and other products with 1/4" hole. Thread-length 3/4". For use with sizes No. 1-3. Maximum SWL 200lbs.	10
Ceiling Clip 	3/4" HF-CLIP-P19	For use with loop end fixing, sizes 1-3. Loop is located in the valley of the clip, then shot-fired into concrete deck or steel beam. During firing, the nail closes the clip, completely entrapping the loop, but still allowing pivotal movement of the cable.	100
	1-1/4" HF-CLIP-P32		100
Decor Cover 	HF-DECOR-COVER-NO2	An aesthetic snap-fit plastic cover, which also protects the Gripple from paint. Available in two versions for sizes No. 2 and 3.	10
	HF-DECOR-COVER-NO3		10
Tensioning Tool 	TOOL-3-5BX-IND	A purpose made tool for quickly tensioning the wire rope. Its use is most appropriate on the higher rated sizes No. 4 and 5.	1
Protective Sleeve Tubing 	HF-SLEEVE-2MM-FT	Black plastic sleeve tubing to prevent contact between dissimilar metals (eg. when hanging copper pipe), or for aesthetic enhancement. Available for sizes 2 and 3.	per ft
	HF-SLEEVE-3MM-FT		per ft
Easy Grip Release Key 	KEY-HF-LOGO	A soft feel plastic handle mounted key for releasing the Gripple self locking fastener. Suitable for use with Gripple No. 1, 2 and 3 hangers.	4
Standard Release Key 	KEY-HF	Standard key for releasing the Gripple self locking fastener.	20
	KEY-NO4		10
	KEY-6-13MM		5
Grip Clips   Beam Clip Vertical Flange Clip   Purlin Clip Z Purlin Clip	HF-GCB24	Beam Clip for 1/16" - 5/32" beam thickness	100
	HF-GCB59	Beam Clip for 3/16" - 5/16" beam thickness	100
	HF-GCB1016	Beam Clip for 5/16" - 5/8" beam thickness	100
	HF-GCB1720	Beam Clip for 5/8" - 3/4" beam thickness	100
	HF-GCVF15	Vertical Flange Clip for 3/64" - 3/16" beam thickness	100
	HF-GCVF57	Vertical Flange Clip for 3/16" - 1/4" beam thickness	100
	HF-GCP45	Purlin Clip	100
	HF-GCZP48	Z Purlin Clip	100

## IMPORTANT USAGE INFORMATION

- **DO NOT USE FOR LOADS OUTSIDE THE STATED RANGE OF THE PRODUCT.** The wedges inside the Gripple work by using the weight of the suspended load to draw the wedge onto the cable, creating a secure grip. If used with too light a load, the wedge may not be able to securely grip the cable. Never exceed the safe working load of the product.
- **COMPLIANCE WITH LOCAL CODES** and where applicable, **NATIONAL CODES** is the buyer and / or installer's responsibility.
- **INTEGRITY OF THE BUILDING STRUCTURE** to which Gripple hangers are attached is the responsibility of the installer and / or specifying engineer.
- **DO NOT PASS COATED CABLE THROUGH THE GRIPPLE.** If using plastic tube covering, ensure that this is removed from the part of the cable which passes through the Gripple. It is essential to maintain metal to metal contact within the Gripple.
- **WHEN PAINTING** ensure that a dedicated Gripple Decor cover is used to cover the Gripple. This will ensure that the movement of the locking wedges inside the assembly is not impaired. After painting, the Gripple should not be repositioned on the cable.
- **DO NOT APPLY LUBRICANT** to any part of the assembly.
- **STATIC LOADS ONLY** are to be supported using Gripple. Do not use for suspending moving objects. Do not install Gripple where it might be subject to movement from HVAC vents, open doors, etc.
- **DO NOT USE FOR HOISTING** such as in a crane or pulley situation.
- **DO NOT USE OUTDOORS.** For indoor use only in a dry environment.
- **IN CHLORINATED ATMOSPHERES** do not use standard Gripple hangers, use Stainless Steel Gripple hangers.
- **DO NOT JOIN TWO CABLE ASSEMBLIES TOGETHER** i.e. using the Gripple fasteners as a splice. A Gripple hanger should consist of one length of Gripple supplied cable and the Gripple fastener.

